

**Instructions
for
SLO-SYN[®] MICRO SERIES
Packaged Translators
Types 230-PT and 430-PT**



Superior
Electric

EXPRESS START-UP PROCEDURE

STEPS NECESSARY TO BECOME OPERATIONAL

This Supplementary Instruction outlines the minimum steps necessary for the Translator Drive to become operational. **FAILURE TO PERFORM THESE STEPS MAY RESULT IN DAMAGE TO THE DRIVE.**

I. POWER SUPPLY

CAUTION: Never connect or disconnect anything from the unit with the power on.

1. Be sure the ac power line is within specified limits and is connected correctly (see Section 3.5 on page 5 of the manual).
2. If the unit is an "X" model, be sure the proper tap is selected on the transformer, depending on the ac mains voltage.
3. Be sure the unit is properly grounded ("G" terminal on the ac power strip).

II. DRIVE

1. Make sure the motor to be used is compatible with the drive. Refer to the manual for a list of compatible motors.
2. Use the motor connection diagrams shown in the manual (Figure 2.2 on page 3) for 4-, 6- and 8-lead motors. When using a 6-lead motor, be sure to insulate and isolate the unused wires. Be sure to insulate all motor leads to prevent inadvertent shorts to ground or to each other.
3. For Reduced Current operation, see Section 3.7.1 on page 6 of the manual. Install a resistor of the appropriate value between the REDUCE CURRENT pin and the LOGIC COMMON pin. Refer to the speed/torque data and the resistor versus current table included in the manual. If you desire to run the Reduce Current remotely, refer to the circuit example shown in Figure 1.
4. To connect to the logic controls, refer to Section 4, Functional Description, in the manual for the connections.
5. Caution: The motor may operate erratically at speeds below 350 steps per second due to motor resonance. Avoid this speed range if a problem exists.

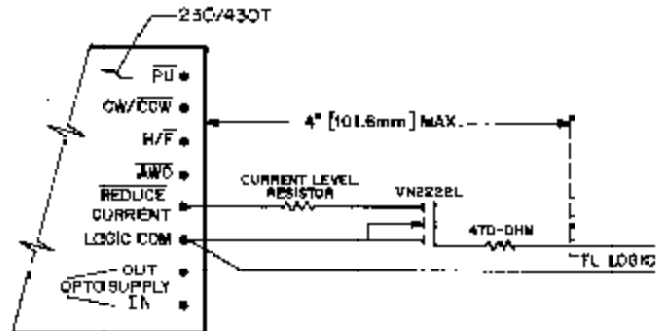

NOTES:--

1. - A "HIGH" level TTL signal on the input activates REDUCE CURRENT.
2. - Keep the FET and current level resistor within four inches of the Module.
3. - Refer to the manual for current level resistor value.

TYPICAL REMOTE REDUCED CURRENT INTERFACE
FIGURE 1

Fuses and Connectors for 230 and 430 series packaged drives

Fuse 3 ampere, 250 volt slow-blow
Bussman part number MDA-3
Littelfuse part number 326003

Motor Connector (mates with female motor connector J2 on drive)
Male Connector Body-AMP part number 206434-1
Pins (5 required)-AMP part number 66506-8
Cable Clamp-AMP part number 206062-1

INSTALLATION GUIDELINES FOR REDUCED NOISE INTERFERENCE

I. General Comments

SLO-SYN Micro Series drives use modern solid-state electronics such as microprocessors to provide the features needed for advanced motion control applications. In some cases, these applications produce electromagnetic interference (EMI, or electrical "noise") that may cause inappropriate operation of the microprocessor logic used in the Micro Series product, or in any other computer-type equipment in the user's system.

This guide is aimed toward helping users avoid such problems at the start by applying "good engineering practices" when designing their systems. Following these guidelines will usually prevent EMI noise from interfering with drive operation.

II. Noise Sources

What causes electrical noise? In general, any equipment that causes arcs or sparks or that switches voltage or current at high frequencies can cause interference. In addition, ac utility lines are often "polluted" with electrical noise from sources outside a user's control (such as equipment in the factory next door).

The following are some of the more common causes of electrical interference:

- power from the utility ac line
- relays, contactors and solenoids
- light dimmers
- arc welders
- motors and motor starters
- induction heaters
- radio controls or transmitters
- switch-mode power supplies
- computer-based equipment
- high frequency lighting equipment
- dc servo and stepper motors and drives

III. Mounting Location

When selecting a mounting location, it is preferable to keep the drive away from obvious noise sources, such as those listed above. If possible, locate the drive in its own metal enclosure to shield it and its wiring from noise sources. If this cannot be done, keep the drive at least three feet from any noise sources.

IV. Wiring Practices - "Dos and Don'ts"

Do the following when installing or wiring your drive or indexer:

- **Do** keep the drive and its wiring as far away from noise sources as possible
- **Do** provide a good, solid ground connection to the ac system earth ground conductor. Bond the drive case to the system enclosure.
- **Do** use a single-point grounding scheme for all related components of a system (this looks like a "hub and spokes" arrangement).
- **Do** keep the ground connection short and direct.
- **Do** use a line filter on the ac input (Corcom type 10B1, 10S1 or 10K1 or equivalent) for noisy ac lines. Particularly bad ac lines may need to be conditioned with a ferroresonant type isolation transformer to provide "clean" power to the drive or indexer.
- **Do** keep signal and drive wiring well separated. If the wires must cross, they should do so at right angles to minimize coupling. Power wiring includes ac wiring, motor wiring, etc. and signal wiring includes inputs and outputs (I/O), serial communications (RS232 lines), etc.
- **Do** use separate conduits or ducts for signal and I/O wiring. Keep all power wiring out of these signal line conduits.
- **Do** use shielded, twisted-pair cables for indexer I/O lines.
- **Do** ground shields only at one end, the indexer/drive end.
- **Do** use twisted-pair, shielded cable for the motor wiring.
- **Do** use solid-state relays instead of electromechanical contact types wherever possible to minimize noise generation.
- **Do** suppress all relays to prevent noise generation. Typical suppressors are capacitors or MOV's. See manufacturers literature for complete information.
- **Do** use shielded, twisted-pair cable for connection to RS232 serial port.

Do Not do the following when installing your drive or indexer:

- **Do not** install sensitive computer-based equipment (such as an indexer/drive) near a source of electromagnetic noise.
- **Do not** bundle power and signal lines together.
- **Do not** fail to use shielded, twisted-pair cables for signals.
- **Do not** fail to properly connect the system grounds.
- **Do not** use "daisy-chained" grounds.
- **Do not** fail to ground signal cable shields at only one end.
- **Do not** assume that power from the ac line is adequately "clean".

V Troubleshooting Guide

Electrical interference problems are common with today's computer-based controls, and such problems are often difficult to diagnose and cure. If such a problem occurs with your system, it is recommended that the following checks be made to locate the cause of the problem.

1. Check the quality of the ac line voltage using an oscilloscope and a line monitor, such as Superior Electric's VMS series. If line voltage problems exist, use appropriate line conditioning, such as line filters or isolation transformers.
2. Be certain all of the previous Dos and Don'ts are followed for location, grounding, wiring and relay suppression.
3. Double check the grounding connections to be sure they are good electrical connections and are as short and direct as possible.
4. Try operating the drive with all suspected noise sources switched off. If the drive functions properly, switch the noise sources on again, one at a time, and try to isolate which ones are causing the interference problems. When a noise source is located, try rerouting wiring, suppressing relays or other measures to eliminate the problem.

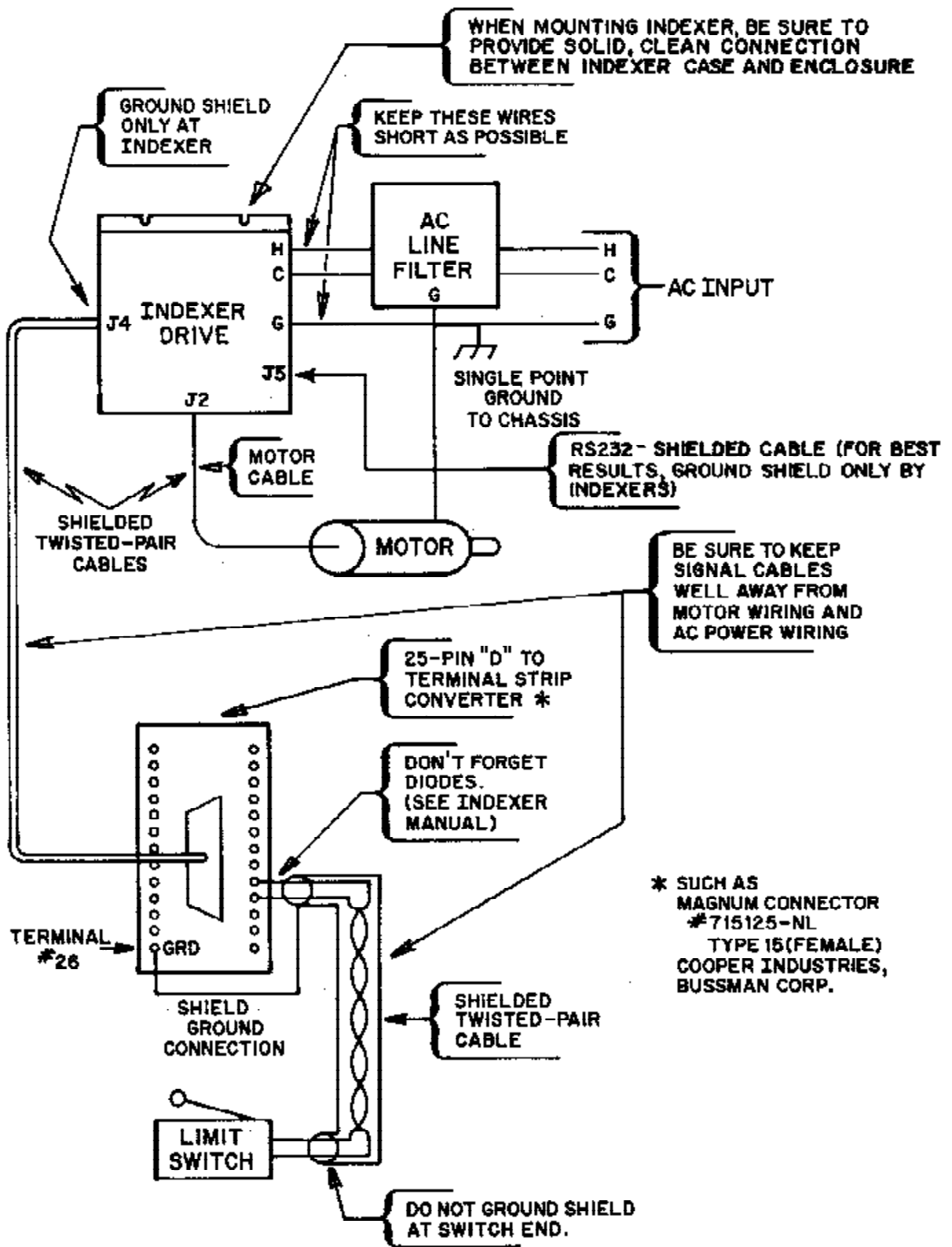

* SUCH AS
MAGNUM CONNECTOR
#715125-NL
TYPE 15(FEMALE)
COOPER INDUSTRIES,
BUSSMAN CORP.

RECOMMENDED WIRING PRACTICE

TABLE OF CONTENTS

230/430-PT MICRO-INDEXER/DRIVE MODULE

	PAGE
PRECAUTIONS	2
WARNINGS, CAUTIONS, LIMITS OF USE, ETC.	2
SECTION 1: INTRODUCTION	2
1.1 Features Overview	2
1.2 Inspection parts list	3
1.3 Using this manual	3
1.3.1 Organization	3
1.3.2 Logic, voltage and programming conventions	3
SECTION 2: MOUNTING, CONNECTIONS AND PIN ASSIGNMENTS	3
2.1 Mounting	3
2.2 Motor Connections	3
2.3 Connection Diagrams	4
2.3.1 J1: Signal I/O	4
2.3.2 J2: Motor	4
2.3.3 J3: Power Input	4
SECTION 3: SPECIFICATIONS	4
3.1 Drive Description	4
3.2 Drive Performance	4
3.3 Motor Compatibility	4
3.4 Drive Mechanical Specifications	4
3.5 Electrical Specifications	5
3.5.1 AC input	5
3.5.2 Output to Motor	5
3.5.3 Control Signal Interface	5
3.6 Environmental Requirements	5
3.7 Reduced Current	5
SECTION 4: FUNCTIONAL DESCRIPTION	6
SECTION 5: CONTROL SIGNAL DESCRIPTIONS	6
SECTION 6: SPEED/TORQUE CURVES	7-12
6.1 Motor Performance	7
SECTION 7: TROUBLESHOOTING	13
SECTION 8: COMPONENT LAYOUT	13
WARRANTY AND LIMITATION OF LIABILITY	13

230-PT/430-PT MICRO-SERIES TRANSLATORS

WARNINGS

- Voltages present in this unit can cause serious or fatal injury. Only qualified personnel should install or perform servicing procedures on this equipment.
- Voltage is present on unprotected pins when unit is operational.
- No short circuit protection for motor outputs is provided in this unit. The AC input is fused.
- Before making changes to the motor or control wiring, turn off all power to the unit, and disconnect its AC power source.
- When power is applied, all parts of the drive circuit should be considered hazardous.
- Allow at least ten minutes for capacitors to discharge as they will remain at high voltages for several minutes after power is removed.

CAUTIONS:

- Assure motor compatibility before using the unit.
- Observe all cooling and temperature limitations. Heatsink temperature must be maintained between 0 and 70 degrees C. (32 and 158 degrees F)
- Unit must not be operated in ambient temperature below 0 degrees C (32 degrees F) or above 50 degrees C (122 degrees F).
- All Windings Off should be used with caution, as all holding torque is lost.
- Do not connect or disconnect motor or signal cables while AC power is applied.
- Do not apply AC power until all connections have been made correctly.
- Do not exceed specified input voltage.
- Do not operate the unit without the enclosures in place as high voltages are present.

LIMITS OF USE:

- Reconfiguration of the circuit in any fashion not shown in this manual will void the warranty.

NOTE:

1. Clockwise and counterclockwise directions are properly oriented when viewing the motor from the label end.

SECTION 1: INTRODUCTION

1.1 FEATURES OVERVIEW

The 230-PT and 430-PT are differentiated as follows:

	MOTOR CURRENT PER PHASE	VA PER PHASE
230-PT	2 Amps peak	56 VA nominal
430-PT	3.5 Amps peak	96 VA nominal

The 230-PT and the 430-PT motor drive/translator package is a low cost, energy efficient, self-contained motor drive module. An integral power supply provides the necessary DC voltages required to operate the drive. This unit is capable of driving a wide range of Superior Electric SLO-SYN stepping motors.

1.2 INSPECTION PARTS LIST

The drive module, heat sink, and power supply come fully assembled as a single unit and are marked with the part number, either 230-PT or 430-PT.

1.3 USING THIS MANUAL

This manual is an installation and operating guide to the 230-PT and 430-PT motor drive and micro-series indexer modules. All the information provided is necessary for using these modules successfully.

We strongly recommend that this manual be read thoroughly and completely before attempting to install and operate the equipment.

1.3.1 Organization

All entries in this manual refer to both the 230-PT and the 430-PT modules, unless otherwise specified.

This manual is organized for the convenience of the operator. Section 2, "Mounting, Connections, and Pin Assignments," provides diagrams and reminders that are necessary, even for the experienced user and installer.

Complete specifications, listed in Section 3, will provide easily referenced information concerning all aspects of installation, power and interface requirements, as well as performance specifications.

Section 4, entitled "Operating Instructions," provides information on how to operate the translator drive.

The remaining sections contain additional drawings and information useful for setting up and operating the indexer modules.

1.3.2 LOGIC, VOLTAGE, and PROGRAMMING CONVENTIONS

- All logic is LOW TRUE. This means that a logic function is active when low and inactive when high. The low true condition is designated by a bar. In the case of half/full, full is active when low.

If a logic control function connector pin is left open, the function will be clamped in a high or inactive condition.

- The red power on LED indicator detects the presence of the +5Vdc voltage output from the internal power supply.
- The unit's AC input is fused. A blown AC input fuse will prevent the power supply from energizing any of its outputs, and the unit will not function.

SECTION 2: MOUNTING, CONNECTIONS AND PIN ASSIGNMENTS

2.1 MOUNTING

The 230-PT and 430-PT modules are mounted by affixing the package to a flat surface in one of four possible configurations, using the brackets provided. Figure 2.1 shows the mounting hole locations and diameters. Use the set of holes that is best suited to your application. The mounting brackets must be attached using only the screws provided. Larger screws will project too far into the enclosure and will damage the unit.

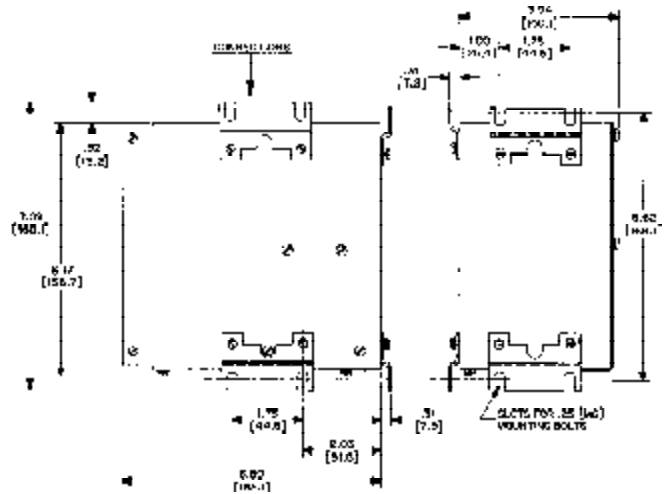

Figure 2.1: Mounting Diagram

The heat sink should always be mounted with the fins oriented vertically, or proper cooling will not occur. Air flow through the unit should not be obstructed. Maximum drive heat sink temperature should not exceed 70 degrees C (158 degrees F).

2.2 MOTOR CONNECTIONS

All motor connections are made via the 8-pin circular AMP connector. Figure 2.2 shows the possible motor wiring configurations.

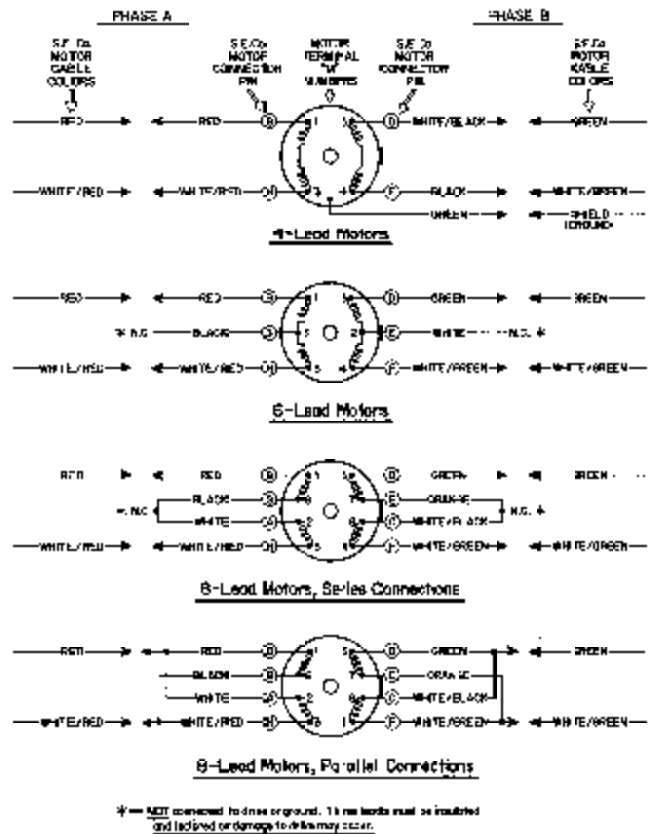

Figure 2.2: Motor Connections

It is suggested that a Superior Electric motor cable be used. They are available as follows:

<u>Length</u>	(Unterminated Leads on motor end) <u>Part Number</u>
10 ft.	B215801-001
25 ft.	B215801-002
50 ft.	B215801-003

<u>Length</u>	(Plug on motor end)* <u>Part Number</u>
10 ft	B216066-001
25 ft.	B216066-002
50 ft.	B216066-003

*Mates with receptacle on M061, M062 and M063 motors that have receptacles (M061-CS08, etc.).

2.3 CONNECTION DIAGRAMS

2.3.1 J1: Signal I/O Connections (15 pin, "D" type, female) (see 3.5.3.2 for pin assignments)

2.3.2 J2: Motor Connections (see 3.5.2 for pin assignments)

The 230-PT and 430-PT can be used with 6-lead and 8-lead SLO-SYN motors. Figure 2.2 shows the correct connections for each possible motor configuration.

2.3.3 J3: Power Input (see 3.5.1.2 for pin assignments)

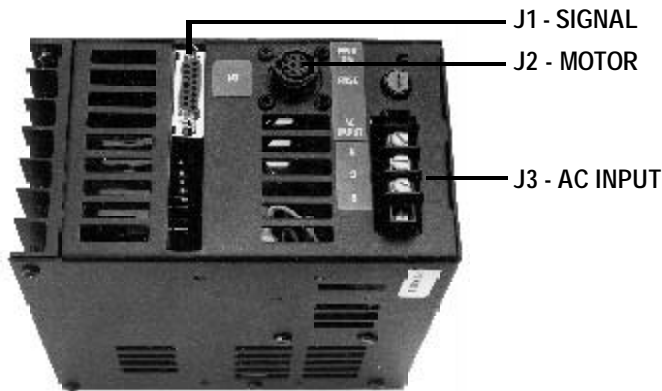

FIGURE 2.3, SIGNAL I/O, MOTOR AND POWER CONNECTORS

SECTION 3: SPECIFICATIONS

3.1 DRIVE DESCRIPTION

Bipolar, speed adjustable, 2-phase chopper drive with translator

Power semiconductor type: H-bridge power IC

Translator: Internal IC

Control signals are optically isolated from the motor drive module (except for Reduce Current)

3.2 DRIVE PERFORMANCE

Step Resolution: Half-step or full-step
 Step Rate: 0 to 10,000 full-steps/sec.
 Speed/torque: See Section 6 for typical Speed/Torque curves.

3.3 MOTOR COMPATIBILITY

	<u>230-PT</u>	<u>430-PT</u>
Motor types:	M0 Series	M0 Series
Frame Sizes:	M061 to M092	M063 to M112
No. of Leads:	4, 6, 8	4, 6, 8
Min. Inductance		0.55 MH
Max. Resistance		3.5 ohms including drive-to-motor cable

Table 3.1: Motor Families and PT Compatibility

MOTORS FOR USE WITH 230-PT WITH CONNECTOR		
M061-CS08	M062-CS09	M063-CS06
M061-CE08	M062-CE09	M063-CS09
		M063-CE09
WITH LEADS		
M061-LS08	M063-LE09	M092-FD09
M061-LE08	M091-FC09	M092-FD310
M062-LS09	M091-FD09	M092-FD8009
M062-LE09	M091-FD8009	M092-FD8109
M063-LS06	M091-FD8109	M092-FD8814
M063-LS09	M092-FC09	
MOTORS FOR USE WITH 430-PT WITH CONNECTOR		
M061-CS08	M062-CE09	M063-CS09
M061-CE08	M063-CS06	M063-CE09
M062-CS09	M063-CE06	
WITH LEADS		
M061-LS08	M091-FD06	M093-FD8011
M061-LE08	M091-FD8106	M093-FD8014
M062-LS09	M092-FC09	M111-FD12
M062-LE09	M092-FD09	M111-FD16
M063-LS06	M092-FD310	M111-FD8012
M063-LE06	M092-FD8009	M112-FD327*
M063-LS09	M092-FD8109	M112-FD8012
M063-LE09	M093-FC14	M112-FJ8012
M091-FC06	M093-FD14	M112-FJ8030

3.4 DRIVE MECHANICAL SPECIFICATIONS

Size
 (inches): 6.5 L x 3.94 W x 7.09 H
 (mm): 165.1 L x 100.01 W x 180.1 H
 Weight: 230-PT: 8.5 lbs. (3.86 kg)
 430-PT: 9.0 lbs. (4.07 kg)

3.5 ELECTRICAL SPECIFICATIONS

3.5.1 AC INPUT

3.5.1.1 Input Power Requirements

	230-PT	340 PT
AC Voltage:	102-132 volts 50/60 Hz	
AC Current:	1.0 Amp	1.5 Amp
Fuse:	250 Volt 3 Amperes	

Total power dissipation (worst case)

230-PT: 45 watts

430-PT 65 watts

3.5.1.2 AC Input Connections

J3: 3 pin screw terminal strip

Pin	Assignment
1	Hot (black)
2	Neutral (white)
3	Ground (green)

3.5.2 OUTPUT TO MOTOR

3.5.2.1 Motor Connections

Assignment: J2: 8-pin twist-lock circular female AMP connector.

Pin	Assignment
1	M4
2	M1
3	No connection
4	Ground
5	No connection
6	M5
7	No connection
8	M3

NOTE: Motor phase A is M1 and M3, and phase B is M4 and M5.

Method: Mates to male AMP connector part number 206434-1 (AMP pin part number 66506-8 and AMP cable clamp part number 206062-1).

Cable type: Superior Electric cables are recommended (see Section 2.2). Cable with shielded, twisted pairs (one pair for each motor phase) is highly recommended. Six twists per foot is a good guideline.

3.5.3 CONTROL SIGNAL INTERFACE

3.5.3.1 Signal Requirements

All connections are done via the J1 15-pin female "D" type connector. Signal requirements for pin #3, Pulse In:

Min. Pulse Width, Low:	15 microseconds
Min. Pulse Width, High:	50 microseconds
Rise Time:	Less than 2 microseconds
Fall Time:	Less than 2 microseconds

3.5.3.2 Pin Assignments for J1

Pin #	Assignment
1	ALL WINDINGS OFF
2	CW/CCW
3	PULSE IN
4	Not Used
5	Not Used
6	Not Used
7	Vo
8	Not Used
9	HALF/FULL
10	OPTO SUPPLY OUT
11	OPTO SUPPLY IN
12	Vo
13	Not Used
14	Not Used
15	Not Used

3.5.3.3 Opto Isolation

Pins 1, 2, 3, and 9 of J1 are optically isolated. Power required for opto-isolators: 4.5 to 7 VDC, 14mA min to 20mA max per input.

Logic "sinking" is required to activate the optically-isolated signals. To use the internal opto-isolator power supply, connect J1-10 to J1-11 and connect the drive's logic common (Vo) to the user's logic common as shown in Figure 5.1. Further details are given in Section 5.

Complete optical isolation of the input signals (except Reduced Current) can be achieved by allowing the control logic common to float with respect to chassis ground when using a separate external Opto Supply, as shown in Figure 5.1. As an alternative, the case or heat sink of the unit can be electrically insulated from chassis ground along with the common side of the motor power supply.

3.6 ENVIRONMENTAL REQUIREMENTS

Indexer Operating Temp: 0°C to +50°C (+32°F to 122°F) free-air ambient

Drive Heat Sink Operating Temp: 0°C to +70°C (+32°F to +158°C) (measured at center of heat sink)

Storage Temp: -40°C to +75°C (-40°F to +167°F)

Humidity: 95% max., noncondensing

Altitude: 10,000 feet (3048 meters) max.

Cooling: Will operate up to 50 degrees C (122 degrees F) so long as maximum heat sink temperature of 70 degrees C (158 degrees F) is maintained; forced-air (fan) cooling may be required.

Note: Forced-air cooling is required to operate the 430 Translator at ambients greater than 35 degrees C (95 degrees F).

3.7 REDUCED CURRENT

WARNING: The following procedure requires disassembly of the enclosure and skilled workmanship must be accomplished. Failure to strictly follow these procedures or entering the enclosure for any other purpose will void the warranty. ALWAYS DISCONNECT POWER AND ALL CABLES BEFORE PROCEEDING. REASSEMBLE THE ENCLOSURE BEFORE POWER IS REAPPLIED.

3.7.1 Reduced Current for 230-PT and 430-PT

It is possible to configure the 230-PT and 430-PT to supply less than rated current to the motor. To do this, a jumper or a resistor is connected between LOGIC COMMON (pin 3) and REDUCE CURRENT (pin 4) on the interface circuit card location J3. These pins protrude through holes in the interface circuit board (See figure 8.1).

To gain access to the pins, first remove the six screws that hold the nameplate side of the enclosure in position and remove it. Then remove the two screws that fasten the heatsink to the other side of the enclosure. Pivot the heatsink together with the attached drive module and indexer card away from the assembly to gain access to pins 3 and 4 of J3.

Care should be taken to keep the resistor or jumper leads less than 2 inches (51mm) long and to prevent them from contacting each other or any other part of the assembly. This signal is not optically isolated.

The proper resistor values or jumper leads and their associated current values are shown in Table 3.7.1.1 for the 230-PT and in Table 3.7.1.2 for the 430-PT.

Table 3.7.1.1 Reduced Current for 230-PT

CURRENT (amps)	RESISTOR (ohms)
1.00	0 (jumper)
1.25	2.49 k, 1/4 watt, 1%
1.50	7.50 k, 1/4 watt, 1%
1.75	23.7 k, 1/4 watt, 1%
2.0	open

Table 3.7.1.2 Reduced Current for the 430-PT

CURRENT (amps)	RESISTOR (ohms)
1.5	0 (jumper)
2.0	1.78k, 1/4 watt, 1%
2.5	5.62k, 1/4 watt, 1%
3.0	16.2k, 1/4 watt, 1%
3.5	open

SECTION 4: FUNCTIONAL DESCRIPTION

4.1 OVERVIEW

In general, the 230-PT and 430-PT electronically convert input pulses into drive signals of the proper sequence and power required to operate a stepping motor: one input pulse being "translated" into one motor step.

To drive the motor, a technique called "chopping" is used. Compared to older drive techniques, chopping gives improved motor performance while allowing the drive circuitry to dissipate less power. The voltage applied to the motor windings is turned on and off very rapidly, or chopped so that the desired current is produced.

The translator circuitry accepts a single pulse at a time as an input and determines which windings (phases) of the motor must be turned on and off in order to advance the motor shaft one step. The translator circuit is fully self-contained and is not accessible through any of the function pins.

4.2 SIGNAL DESCRIPTION

The 230-PT and 430-PT are configured for operation by the means of the pin assignments. How these functions are treated by the motor drive module is explained in Section 5.

Input pulses, one for each desired motor step, are received by the translator circuit on the PULSE IN (PU) pin.

Two input control signals alter the sequence of motor winding which will be energized. The CCW pin controls which direction the motor will move and the HALF/FULL (H/F) pin determines whether a half or full step is taken.

Even when the motor is stationary, current is flowing through one or two of the windings. The magnetic field produced by this current holds the shaft firmly with a force specified as the "holding torque." The input control signal, ALL WINDINGS OFF (AWO), turns off all current to the motor, thus allowing the shaft to be turned manually.

SECTION 5: CONTROL SIGNAL DESCRIPTIONS

(Reference Figure 2.2)

Connector J1, 15-pin "D" type connector, female

Note: The following discussion assumes the internal opto power supply is being used when describing signal functions.

5.1 AWO (ALL WINDINGS OFF) - Pin 1

A logical low or connection to LOGIC COMMON turns off all power to the motor windings.

WARNING:

Holding torque is eliminated when this signal is active. Insure that the motor load, when released by this command, will not injure property or personnel.

5.2 CW/CCW (DIRECTION) - Pin 2

A logical high or an open connection causes the motor shaft to step in the clockwise direction as viewed from the label end of the motor.

A logical low, or connection to LOGIC COMMON results in counter-clockwise rotation.

5.3 PU (PULSE IN) - Pin 3

A low to high (positive going edge) transition on this pin causes the motor to take one step. Maximum frequency is 15KHZ.

5.4 DO NOT USE - Pin 4

This pin is not available to the operator

5.5 DO NOT USE - Pin 5

This pin is not available to the operator

5.6 DO NOT USE - Pin 6

This pin is not available to the operator

5.7 LOGIC COMMON (Vo) - Pin 7

Reference point for inputs and outputs; connected internally to Vom and to the module's aluminum case.

5.8 DO NOT USE - Pin 8

This pin is not available to the operator.

5.9 H/F (HALF/FULL) - Pin 9

A logical low or connection to LOGIC COMMON, causes the motor to step the full step angle indicated in its specifications. A logical high (open) causes the motor to take a "half-step" equal to half its specified step angle. When operated in half-step mode the motor provides smoother motion with finer resolution, but at approximately 30% less the torque.

Note: If the H/F input is switched low with the drive power on, it is possible to get a full step, one winding on ("wave mode") condition that results in reduced motor torque. To avoid this, power to the unit must be turned off whenever this input is activated.

5.10 OPTO SUPPLY OUT - Pin 10

Supplies proper voltage for opto inputs from an internal source. By connection OPTO SUPPLY OUT to OPTO SUPPLY IN, the user can apply the 230-PT or 430-PT internal power supply for optically isolated signals. This allows logic functions to be activated by "sinking" (pulling them low; i.e., connecting them to LOGIC COMMON via an external switch or logic gate).

In this case, the user's circuitry is not isolated from the translator.

5.11 OPTO SUPPLY IN - Pin 11

Connection of opto isolator power supply. May be connected as described in 5.10, or user may provide a separate source for opto-isolators and "sink" to activate, as shown in Figure 5.1. This method may provide the best noise immunity, since the user's circuitry is optically isolated from the translator.

5.12 LOGIC COMMON (Vo) - Pin 12

See Section 5.7 above.

5.13 DO NOT USE - Pin 13

This pin not available to the operator.

5.14 DO NOT USE - Pin 14

This pin not available to the operator.

5.15 DO NOT USE - Pin 15

This pin not available to the operator.

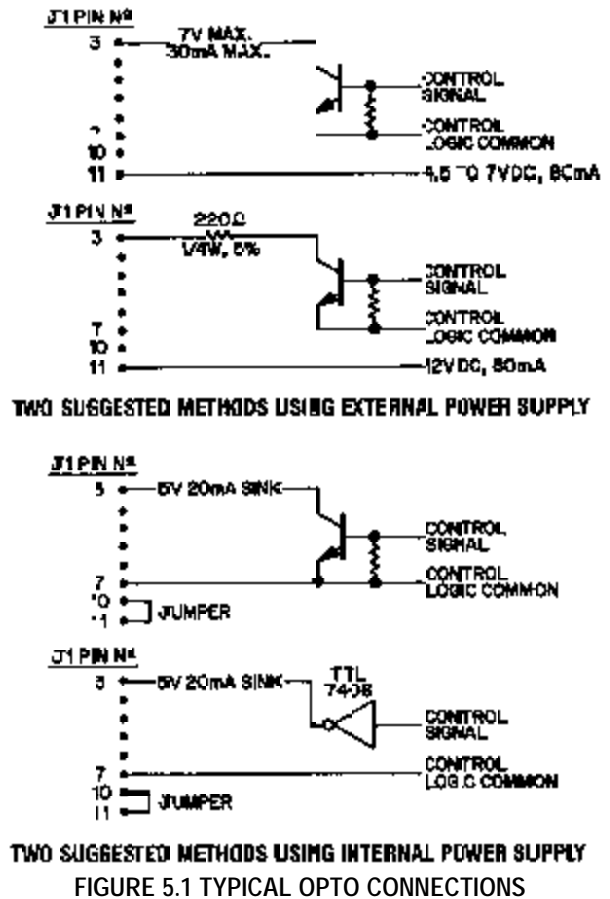

FIGURE 5.1 TYPICAL OPTO CONNECTIONS

SECTION 6: SPEED/TORQUE CURVES

6.1 MOTOR PERFORMANCE

All stepping motors exhibit instability at their natural frequency and harmonics of that frequency. Typically, this instability will occur at speeds between 50 and 500 full steps per second and, depending on the dynamic motor load parameters, can cause excessive velocity modulation or improper positioning.

There are also other instabilities which may cause a loss of torque at stepping rates outside the range of natural resonance frequencies. One such instability is broadly identified as mid-range instability. This is identified by the dotted area (...) on the speed torque curves.

Usually, the dampening of the system and acceleration/deceleration through the resonance areas aids in reducing instability to a level that provides smooth shaft velocity and accurate positioning. If instability does cause unacceptable performance under actual operation conditions, the following techniques can be used to reduce velocity modulation.

1. Avoid constant speed operation at the motor's unstable frequencies. Select a base speed that is above the motor's resonant frequencies and adjust acceleration and deceleration to move the motor through unstable regions quickly.
2. The motor winding current can be reduced as discussed in Section 3.7. Lowering the current will reduce torque proportionally. The reduced energy delivered to the motor can decrease velocity modulation.
3. Use half-step mode of operation. Note that this also halves the shaft speed for a given input pulse rate.

TYPICAL SPEED VS. TORQUE CHARACTERISTICS

230 SERIES MOTION CONTROLS

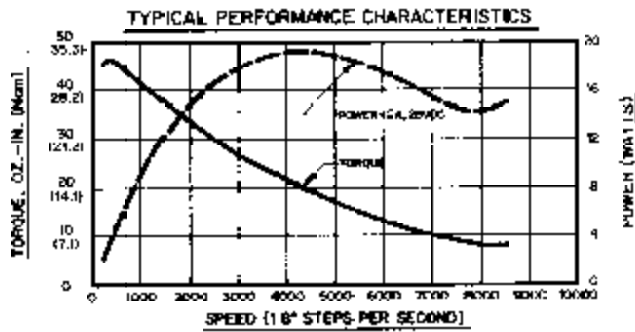

SERIES CONNECTION
MO61-CS08 AND MO61-LS08 MOTORS

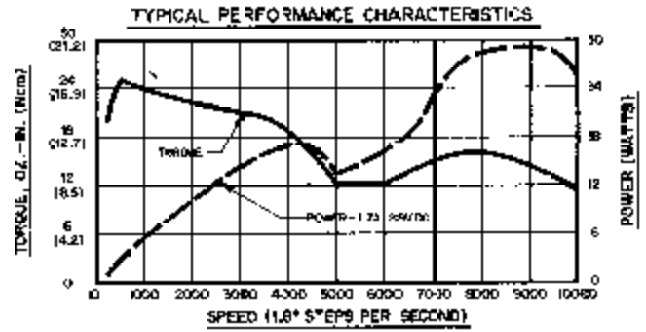

PARALLEL CONNECTION
MO61-CE08 AND MO61-LE08 MOTORS

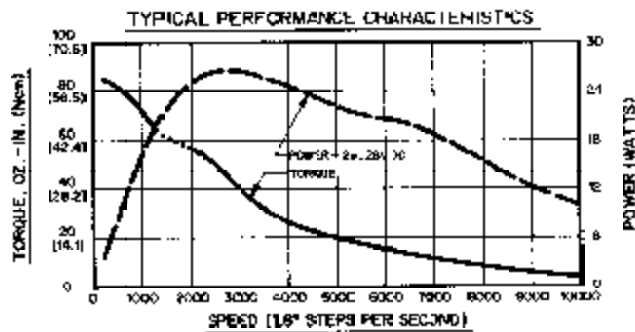

SERIES CONNECTION
MO62-CS09 AND MO62-LS09 MOTORS

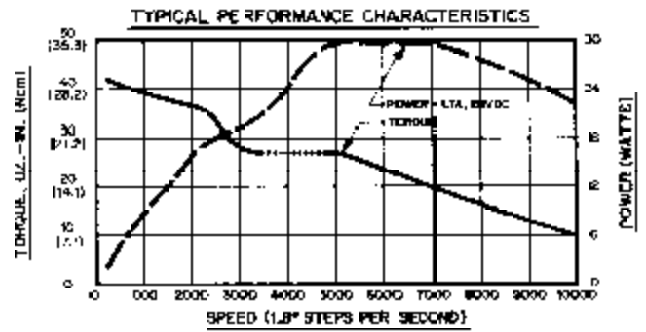

PARALLEL CONNECTION
MO62-CE09 AND MO62-LE09 MOTORS

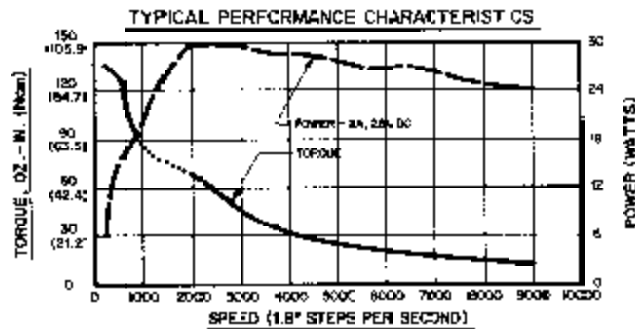

SERIES CONNECTION
MO63-CS09 AND MO63-LS09 MOTORS

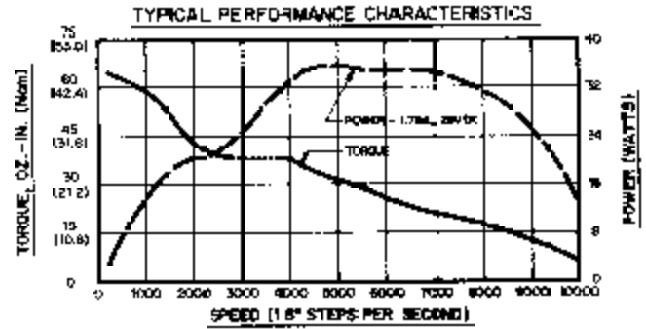

PARALLEL CONNECTION
MO63-CE09 AND MO63-LE09 MOTORS

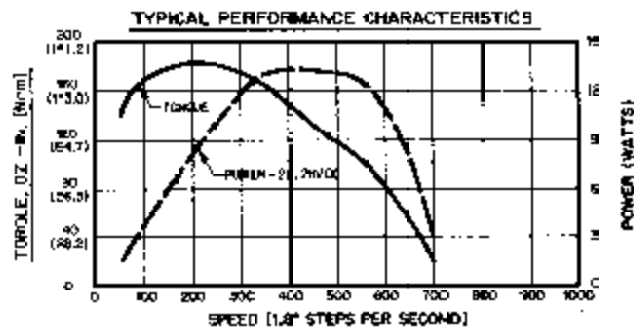

SERIES CONNECTION
MO63-CS06 AND MO63-LS06 MOTORS

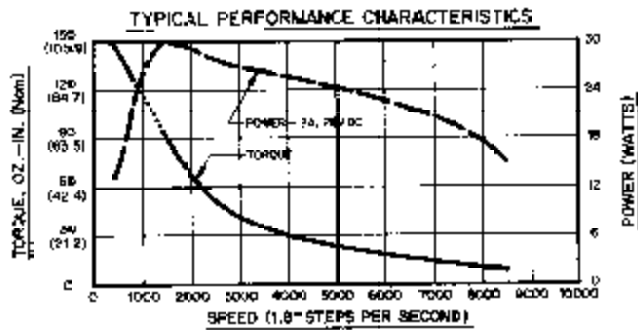

**SERIES CONNECTION
M091-FC09 AND M091-FD09 MOTORS**

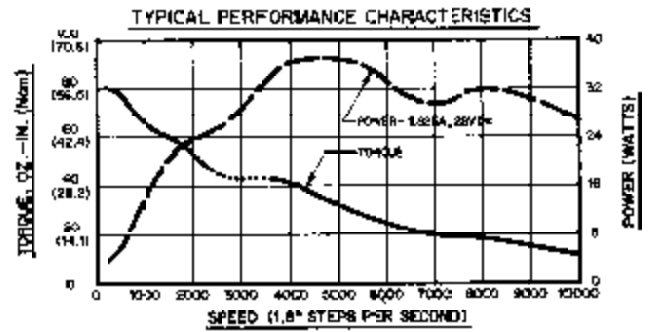

**PARALLEL CONNECTION
M091-FD8009 AND M091-FD8109 MOTORS**

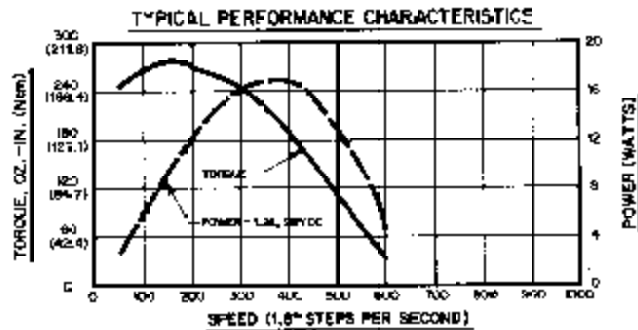

**SERIES CONNECTION
M092-FC09 AND M092-FD09 MOTORS**

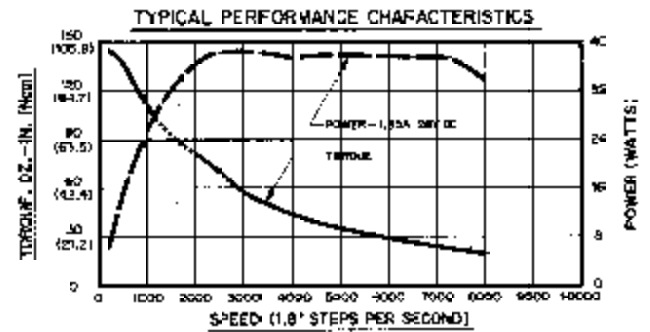

**PARALLEL CONNECTION
M092-FD8109 AND M092-FD8309 MOTORS**

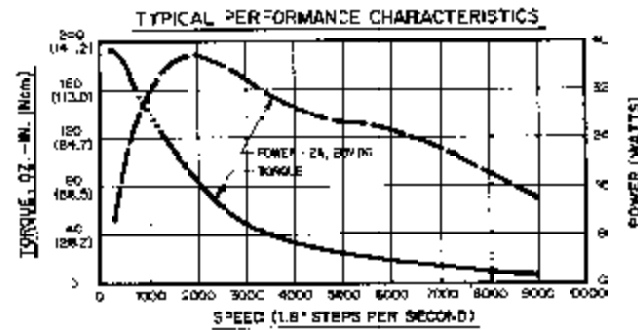

**SERIES CONNECTION
M092-FD310 MOTOR**

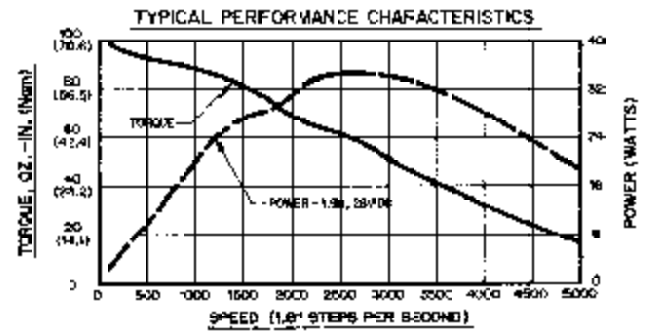

**PARALLEL CONNECTION
M092-FD8814 MOTOR**

TYPICAL SPEED VS. TORQUE CHARACTERISTICS

430 SERIES MOTION CONTROLS

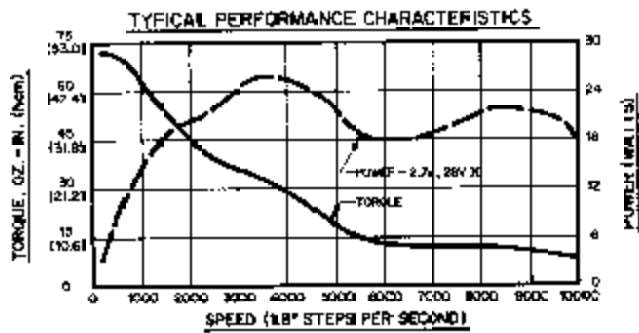

SERIES CONNECTION
MO61-CS08 AND MO61-LS08 MOTORS

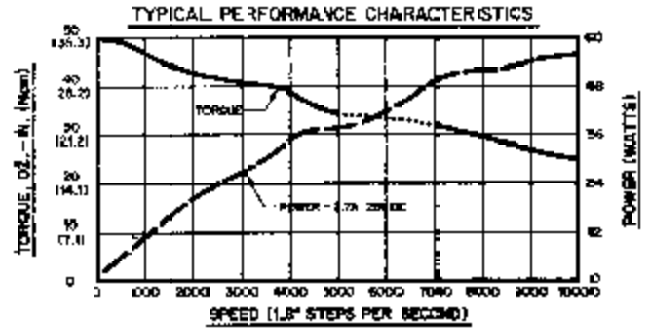

PARALLEL CONNECTION
MO61-CE08 AND MO61-LE08 MOTORS

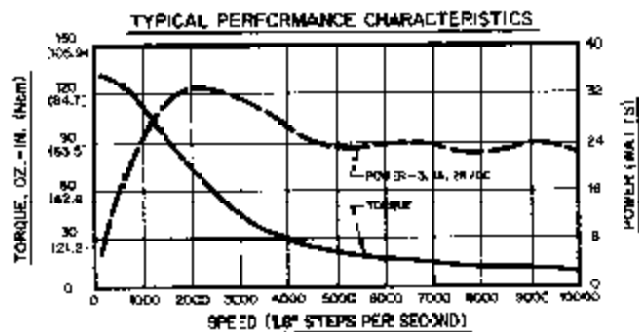

SERIES CONNECTION
MO62-CS09 AND MO62-LS09 MOTORS

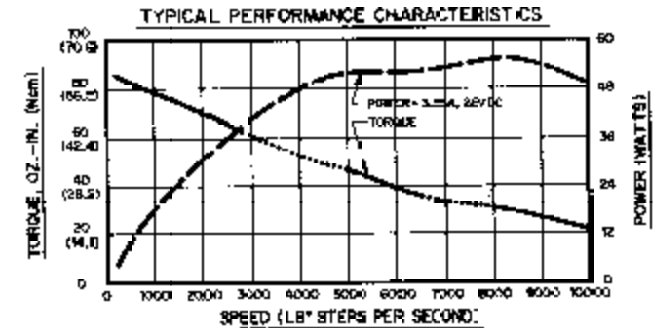

PARALLEL CONNECTION
MO62-CE09 AND MO62-LE09 MOTORS

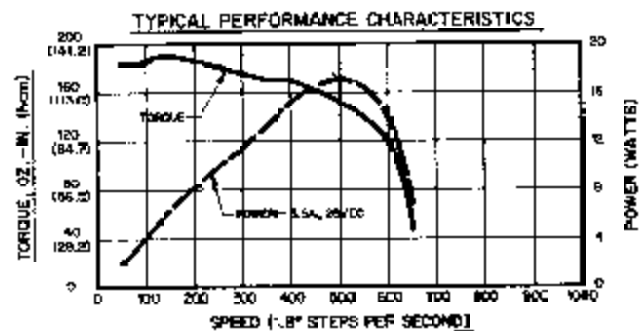

SERIES CONNECTION
MO63-CS06 AND MO63-LS06 MOTORS

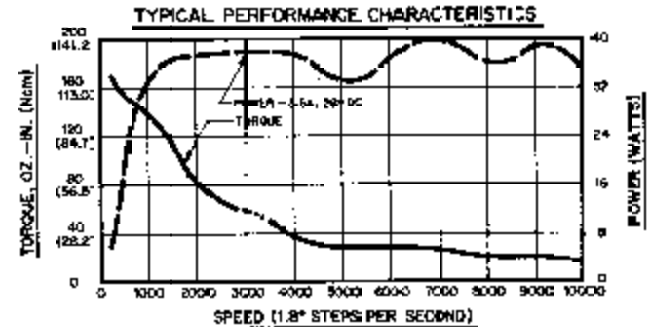

PARALLEL CONNECTION
MO63-CE06 AND MO63-LE06 MOTORS

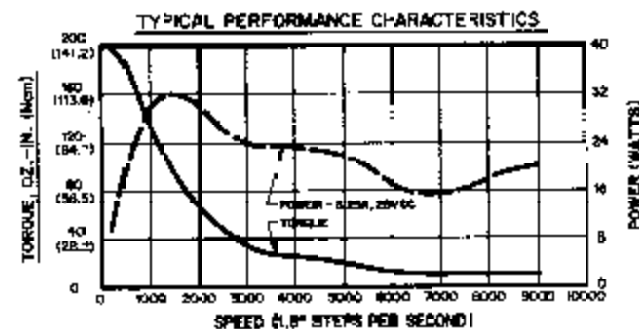

SERIES CONNECTION
MO63-CS09 AND MO63-LS09 MOTORS

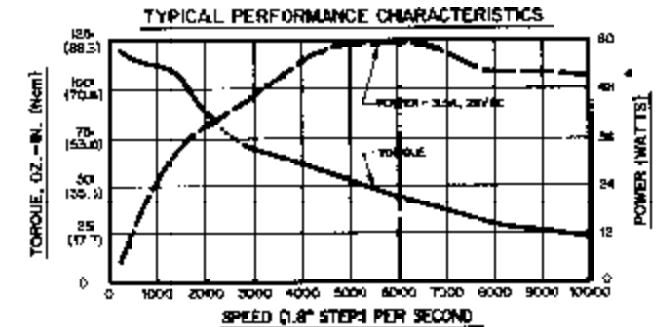

PARALLEL CONNECTION
MO63-CE09 AND MO63-LE09 MOTORS

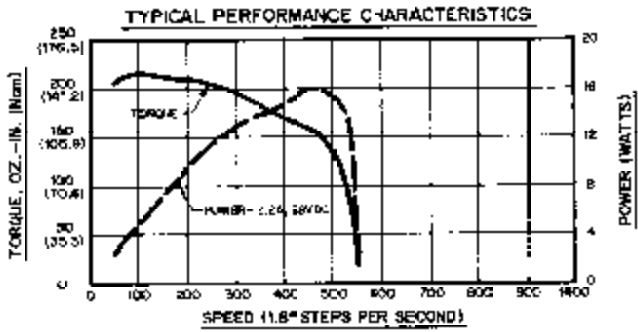

**SERIES CONNECTION
MO91-FC06 AND MO91-FD06 MOTORS**

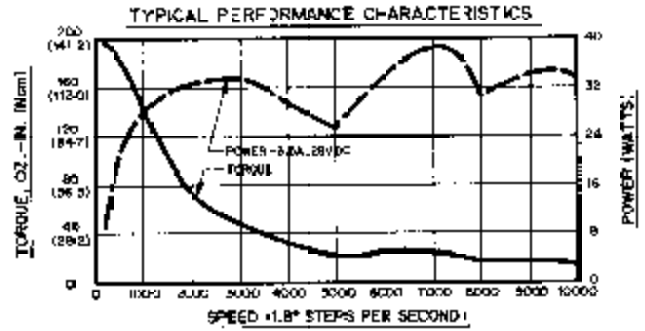

**PARALLEL CONNECTION
MO91-FD06106 MOTOR**

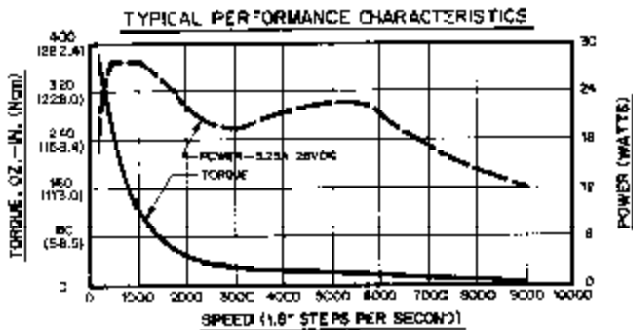

**SERIES CONNECTION
MO92-FC09 AND MO92-FD09 MOTORS**

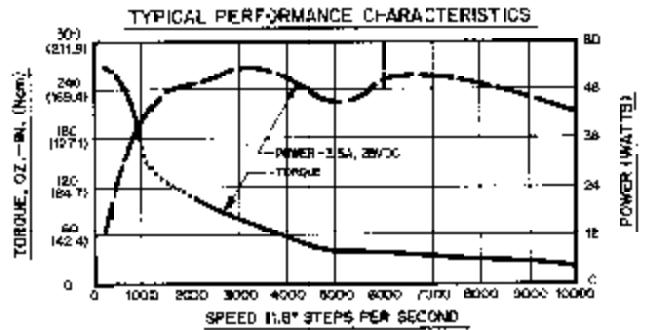

**PARALLEL CONNECTION
MO92-FD08109 AND MO92-FD0809 MOTORS**

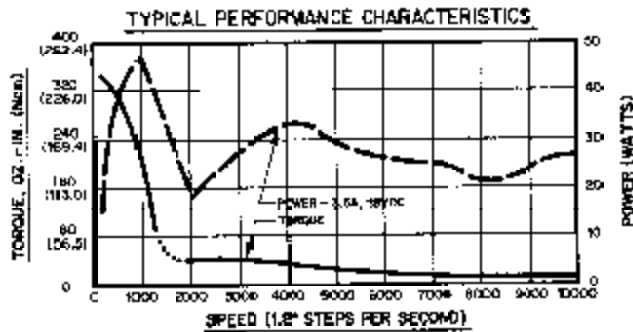

**SERIES CONNECTION
MO92-FD3-10 MOTOR**

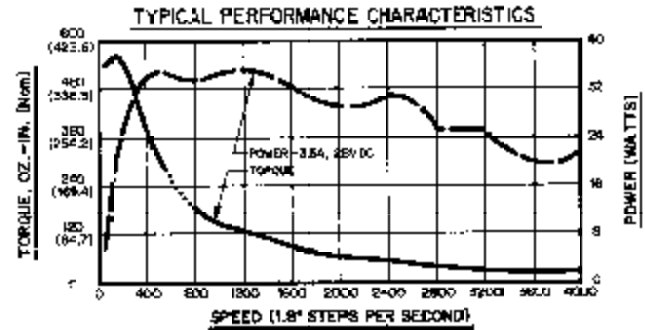

**SERIES CONNECTION
MO93-FD0011 MOTOR**

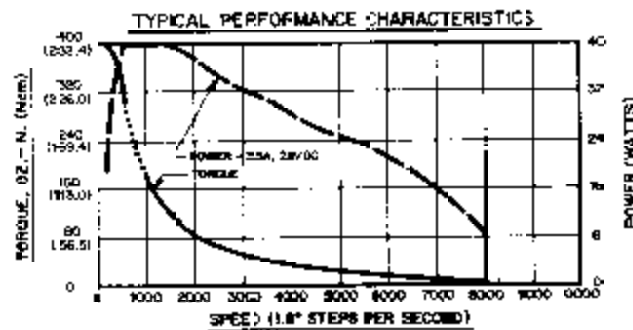

**SERIES CONNECTION
MO93-FC14 AND MO93-FD14 MOTORS**

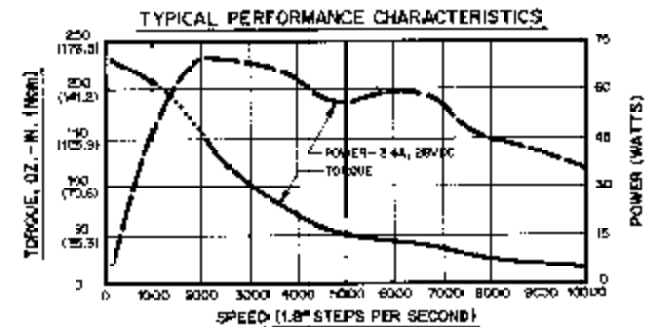

**PARALLEL CONNECTION
MO93-FD0014 MOTOR**

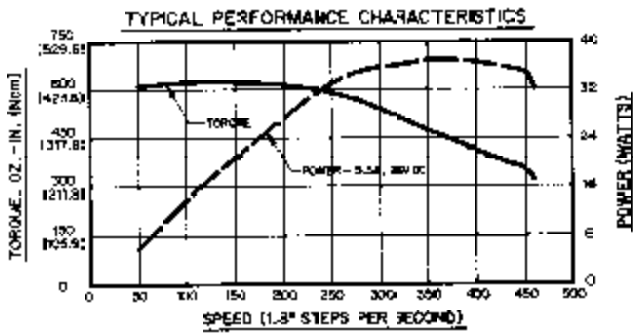

SERIES CONNECTION
M111-FD12 MOTOR

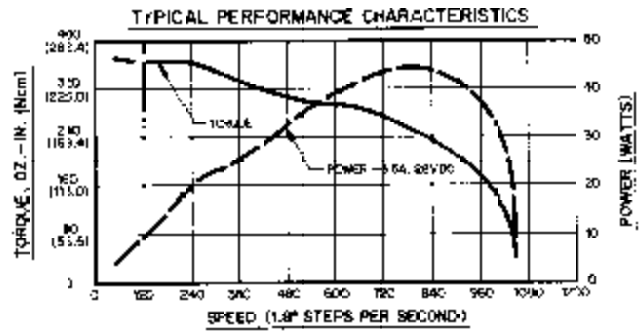

PARALLEL CONNECTION
M111-FD8012 MOTOR

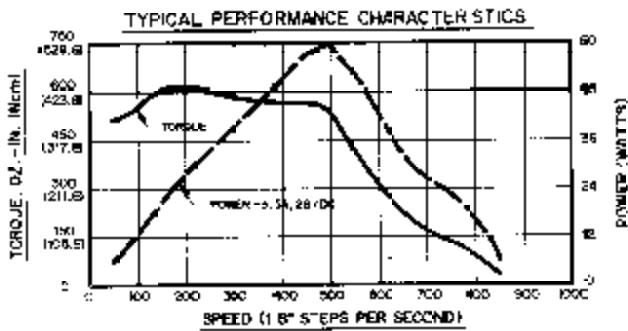

SERIES CONNECTION
M112-FJ8030 MOTOR

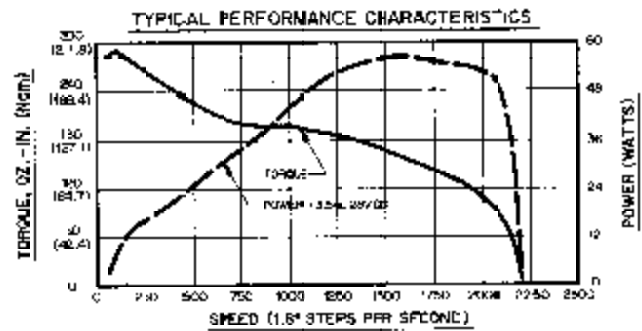

PARALLEL CONNECTION
M112-FJ8030 MOTOR

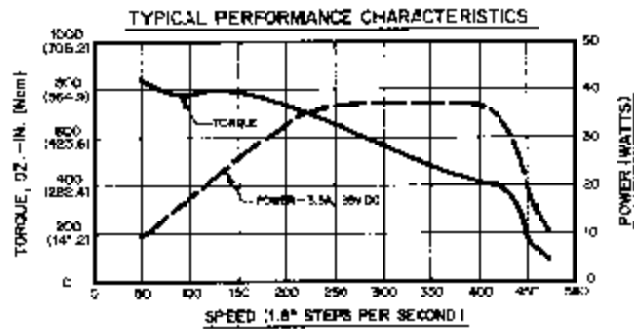

SERIES CONNECTION
M112-FJ327 MOTOR

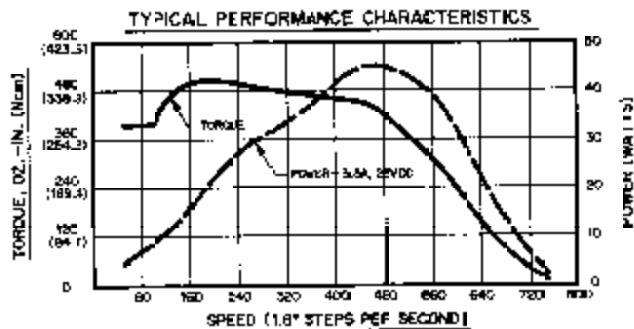

SERIES CONNECTION
M111-FD16 MOTOR

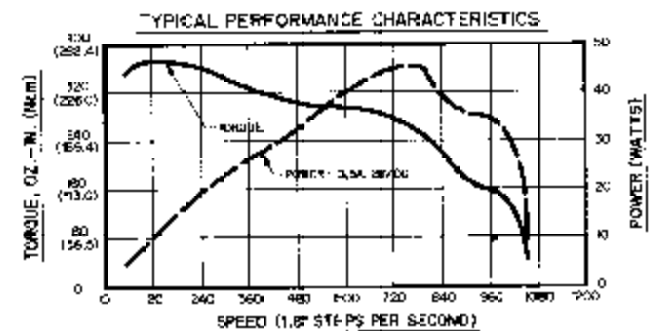

PARALLEL CONNECTION
M112-FD8012 AND M112-FJ8012 MOTORS

SECTION 7: TROUBLESHOOTING

WARNING

Motors connected to this drive can develop high torque and large amounts of mechanical energy.

Keep clear of the motor shaft, and all parts mechanically linked to the motor shaft.

Turn off the power to the drive before performing work on parts mechanically coupled to the motor.

If installation and operation instructions have been followed carefully, this unit should perform correctly. If motor fails to step properly, the following checklist will be helpful.

In General:

- Check all installation wiring carefully for wiring errors or poor connections.
- Check to see that the proper AC voltage level is being supplied to the unit.
- Be sure the motor is compatible for use with this unit.

7.1 IF MOTOR DIRECTION (CW, CCW) IS REVERSED, CHECK:

Connections between the drive and the motor. Motor wires may have been reversed accidentally on one phase. For example, swap the position of the M1 and M3 (red and white/red wires).

7.2 IF THE MOTOR MOTION IS ERRATIC, Check:

Input pulses not of proper level or width.

Supply voltage out of tolerance.

Operation in area of motor instability (dotted portion of torque/speed curve).

7.3 IF TORQUE IS LOW, Check:

AWO (All Windings Off) active or REDUCED CURRENT active.

Improper supply voltage.

Operation in area of motor instability (dotted portion of torque/speed curve).

If a malfunction occurs that cannot be corrected by making these correction, contact Superior Electric.

SECTION 8: COMPONENT LAYOUT

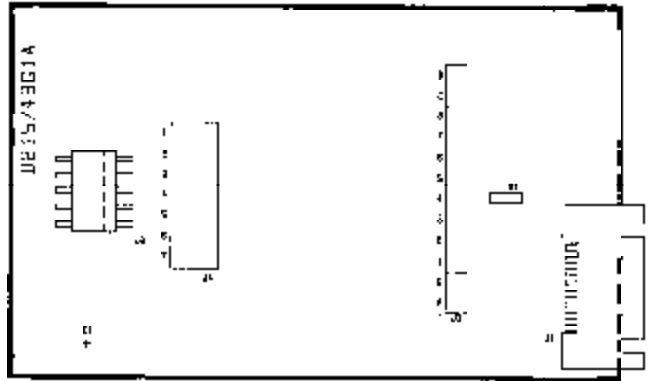

FIGURE 8.1
INTERFACE CIRCUIT CARD

WARRANTY AND LIMITATION OF LIABILITY

Superior Electric, Bristol, Connecticut, warrants to the first end user purchaser (the "purchaser") of equipment manufactured by Superior Electric that such equipment, if new, unused and in original unopened cartons at the time of purchase, will be free from defects in material and workmanship under normal use and service for a period of two years from date of shipment from Superior Electric's factory or a warehouse of Superior Electric in the event that the equipment is purchased from Superior Electric or for a period of two years from the date of shipment from the business establishment of an authorized distributor of Superior Electric in the event that the equipment is purchased from an authorized distributor.

SUPERIOR ELECTRIC'S OBLIGATION UNDER THIS WARRANTY SHALL BE STRICTLY AND EXCLUSIVELY LIMITED TO REPAIRING OR REPLACING, AT THE FACTORY OR A SERVICE CENTER OF SUPERIOR ELECTRIC, ANY SUCH EQUIPMENT OR PARTS THEREOF WHICH AN AUTHORIZED REPRESENTATIVE OF THE COMPANY FINDS TO BE DEFECTIVE IN MATERIAL OR WORKMANSHIP UNDER NORMAL USE AND SERVICE WITHIN SUCH PERIOD OF TWO YEARS. SUPERIOR ELECTRIC RESERVES THE RIGHT TO SATISFY SUCH OBLIGATION IN FULL BY REFUNDING THE FULL PURCHASE PRICE OF ANY SUCH DEFECTIVE EQUIPMENT. This warranty does not apply to any equipment which has been tampered with or altered in any way, which has been improperly installed or which has been subject to misuse, neglect or accident.

THE FOREGOING WARRANTY IS IN LIEU OF ANY OTHER WARRANTIES, EXPRESS OR IMPLIED, INCLUDING, WITHOUT LIMITATION, ANY IMPLIED WARRANTY OF MERCHANTABILITY OR FITNESS FOR A PARTICULAR PURPOSE, and of any other obligations or liabilities on the part of Superior Electric; and no person is authorized to assume for Superior Electric any other liability with respect to equipment manufactured by Superior Electric. Superior Electric shall have no liability with respect to equipment not of its manufacture. SUPERIOR ELECTRIC SHALL HAVE NO LIABILITY WHATSOEVER IN ANY EVENT FOR PAYMENT OF ANY INCIDENTAL OR CONSEQUENTIAL DAMAGES, INCLUDING, WITHOUT LIMITATION, DAMAGES FOR INJURY TO ANY PERSON OR PROPERTY.

Written authorization to return any equipment or parts thereof must be obtained from Superior Electric. Superior Electric shall not be responsible for any transportation charges.

IF FOR ANY REASON ANY OF THE FOREGOING PROVISIONS SHALL BE INEFFECTIVE, SUPERIOR ELECTRIC'S LIABILITY FOR DAMAGES ARISING OUT OF ITS MANUFACTURE OR SALE OF EQUIPMENT, OR USE THEREOF, WHETHER SUCH LIABILITY IS BASED ON WARRANTY, CONTRACT, NEGLIGENCE, STRICT LIABILITY IN TORT OR OTHERWISE, SHALL NOT IN ANY EVENT EXCEED THE FULL PURCHASE PRICE OF SUCH EQUIPMENT.

Any action against Superior Electric based upon any liability or obligation arising hereunder or under any law applicable to the sale of equipment, or the use thereof, must be commenced within one year after the cause of such action arises.

The right to make engineering refinements on all products is reserved. Dimensions and other details are subject to change.

Distribution Coast-To-Coast and International

Superior Electric, is a global leader in the engineering, manufacturing, and marketing of precision motion and control products for industrial applications. All SLO-SYN® step motors, servo motors and controls are backed by highly specialized engineers and service people who can help solve your production challenges. Superior Electric's capabilities and products have improved operations for companies around the world.

Through an extensive authorized distributor network, Superior Electric products are available worldwide. These distributors provide convenient services by offering technical support, replacement parts, and literature, as well as an extensive inventory of models off-the-shelf for the fastest possible delivery. Call Superior Electric customer service for ordering and application information or for the address of the nearest authorized distributor for Superior Electric products.

Superior Electric

SLO-SYN® Step/Servo Motors and Controls

POWERSTAT® Variable Transformers

SUPERCON® Electrical Connectors

BRONCO® AC and DC Drives

NEXTRIDE™ Adjustable Frequency Drives

LUXTRON® Lighting Controls

STABILINE® Power Protection Products

5-WAY® Binding Posts

SECO® Adjustable Speed Drives



The Only Factory Authorized Repair Center for Superior Electric Stepper Drive & Motor Repair

Motor Systems Inc.
460 Milford Parkway
Milford, OH . 45150
www.motorsystems.com
513-576-1725